

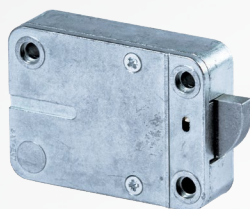

Caractéristiques

Clavier

- 10 Clés alpha-numeric
- Tester clavier
- Clavier illuminé
- LED rouge
- Bip sonore
- Compartiment pile
- Lecteur clé Dallas
- Clavier fixe / rotatif
- 4 Configurations sélectionnable par clavier
- Alimentation:
 - 9V pile alcaline
 - Compartiment pile grand
 - Alimentation externe



RotoBolt

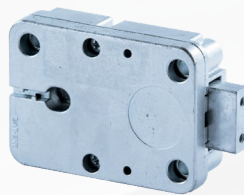

StraightBolt



SpringBolt



MotorLock

Serrures 2 codes

- Manager
- 1 Code
- Temporisation 1 - 99 minutes
- Fenêtre ouverte 1 - 19 minutes
- Pénalité

Serrures 10 codes

- Manager
- 8 Codes
- 1 Code passer temporisation
- Temporisation 1 - 99 minutes
- Fenêtre ouverte 1 - 19 minutes
- Alarme silencieuse
- Désactiver à distance
- Pénalité
- Clés Dallas
- 4 Yeux

Pulse

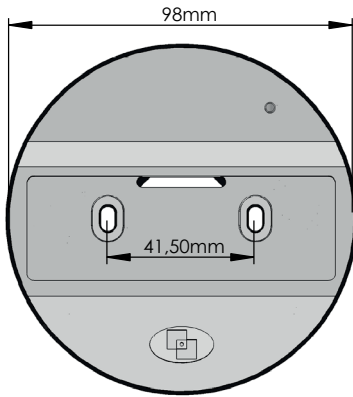

RotoBolt

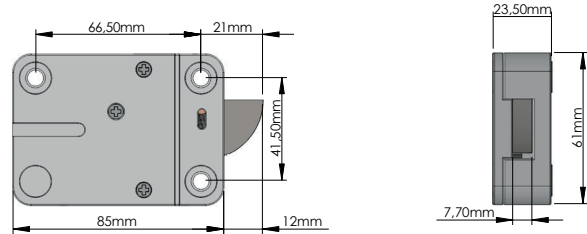

StraightBolt

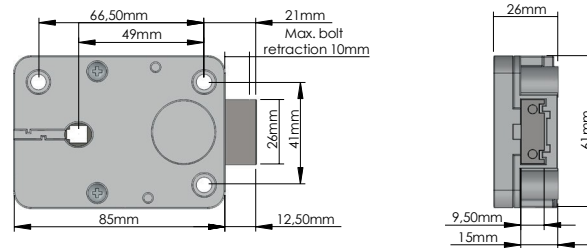

SpringBolt

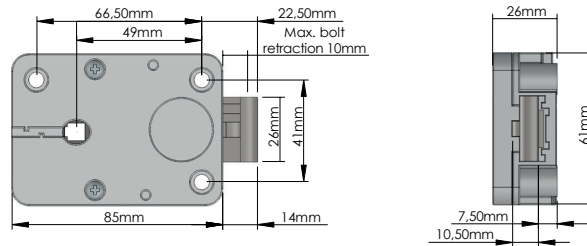

MotorLock

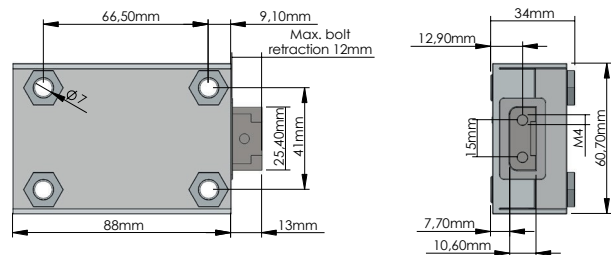

GLOBAL HEADQUARTERS

Tecnosicurezza
Via C. Battisti, 276
37057 S.Giovanni Lup.(VR)
ITALY
info@tecnosicurezza.it
www.tecnosicurezza.it

USA HEADQUARTERS

Tecnosicurezza
50, Thomas Lane
Versailles, KY 40383
USA
info@usatecno.com
www.usatecno.com

SPAIN HEADQUARTERS

Tecnosicurezza
C/Menor, 4 - Nave 10, Pol Ind. "La Mina"
28770 Colmenar Viejo
SPAIN
info@tecnosicurezza.es
www.tecnosicurezza.es